

# Consumer Manual



# SaunaMed

**EMR Neutral™**  
P A T E N T E D



**Dear Customer,**

Thank you for purchasing a SaunaMed Sauna.  
Before using your new sauna please read this consumer's manual carefully.

**Contents:**

Preview	1
Operating Conditions	2
Specifications	3
General Safety Rules	5
Assembly & Installation	6
Operation	22
Tips for use	30
Problem Solving	31



# WARNING: DISCONNECT THE SAUNA FROM THE MAINS POWER SUPPLY BEFORE CHANGING ANY PARTS OR CARRYING OUT A SERVICE.

## Preview

All growth depends on sunlight. But 40% of the ultraviolet and the high energy rays of the sun are harmful to the human body; the remaining 60% of the sun's energy is beneficial, comprising infrared rays.

Our infrared sauna uses these invisible (5.6-15 $\mu$ m) infrared rays to increase cell tissue resonance, accelerate blood circulation and improve organic functions.

Infrared sauna therapy is becoming increasingly popular and accepted by the medical fraternity, with more studies now supporting the science behind this exciting new technology.

An infrared sauna can help relieve pain and improve wound healing and recovery by increasing blood circulation. The increased metabolic rate experienced in an infrared sauna actually burns calories as the body works to sweat. This aids fat burning, improves cardiac fitness, strengthens the heart, helps eliminate toxins and improves cellulite and general skin tone. A 30-minute session in an infrared sauna burns the same calories as a 10-kilometer run.

The quality Kenwood stereo system fitted in our saunas aids relaxation with sound therapy and helps relieve stress.

## Operating Conditions

- Temperature: 41°F - 104°F
- Humidity: ≤ 85%
- Pressure: 700-1060 hpa
- Power supply: 110V
- Indoor use only

**Do not install closer than 0.5 inches to wall.**

## Features

- Wooden construction.
- Digital microprocessor controlled.
- Temperature adjustable from 68°F – 140°F (5°F increments).
- Adjustable dwell time from 0 to 60 minutes.
- Digital temperature sensor.
- Soft touch keypad.
- Long-life DuraWave™ EMR Neutral™ pure ceramic FAR infrared heaters.

## Maintenance

- Clean the sauna room with a soft wet cloth. NEVER use petrol, alcohol, benzene or any other such chemical to clean the unit.
- No maintenance or service of electronic components is required unless faulty.

## Transportation and Storage

- Avoid exposure to rain, snow or strong collisions during transport.
- Do not store in damp environments.

### Size

Model No.	Measurements (W x D x H) (Inches)
001 Series	35.4 x 35.4 x 74.8
002 Series	47.2 x 39.4 x 74.8
003 Series	59.1 x 47.2 x 74.8
004 Series	70.9 x 47.2 x 74.8
006 Series	59.1 x 23.6 x 74.8

### Electrical Configurations

Model No.	Rated Voltage	Rated Amps	Frequency	Input Power
001 Series	110V	15	60Hz	1400W
002 Series	110V	15	60Hz	1750W
003 Series	110V	20	60Hz	1920W
004 Series	110V	20	60Hz	1920W
006 Series	110V	20	60Hz	1920W



← 20 A

### QJ-3H

2-POLE 3-WIRE PLUG 6-20P

- 16/3 SPT-2,SPT-3,SVT,SJT,SJTW,SJTO,SJTOW,SJTOO,SJTOOW  
ST,STW,STO,STOW,STOO,STOOW
- 14/3 SJT,SJTW,SJTO,SJTOW,SJTOO,SJTOOW,ST,STW,STO  
STOW,STOO,STOOW3
- 12/3 SJT,SJTW,SJTO,SJTOW,SJTOO,SJTOOW,ST,STW  
STO,STOW,STOO,STOOW



← 15 A

### QJ-3

2-POLE 3-WIRE PLUG 5-15P

- 18/3 SPT-2,SPT-3,S,SJ,SO,SOO,SOOOW,SOW,SJO,SJOW,SJOO,SJOOW  
SVT,SVTO,SVTOO,SJT,SJTW,SJTO,SJTOW,SJTOO,SJTOOW
- 17/3 SVT,SVTO,SVTOO
- 16/3 SPT-2,SPT-3,S,SO,SOO,SOOOW,SOW,SJO,SJOW,SJOO,SJOOW  
SJ,SJT,SJTW,SJTO,SJTOW,SJTOO,SJTOOW
- 14/3 SJT,SJTW,SJTO,SJTOW,SJTOO,SJTOOW
- 12/3 SJT,SJTW,SJTO,SJTOW,SJTOO,SJTOOW

## **General Safety Rules**

- All wiring to the sauna heater and accessories shall be routed away from any direct radiation from the sauna heater.
- Any receptacle shall not be installed inside the sauna.
- The sauna shall not be subjected to water spray.
- No plumbing fixtures (taps, etc.) are to be installed in the sauna.
- The door of the sauna should not include any locking or latching system, malfunction of which could cause entrapment inside the sauna.
- If located in a bathroom, it must be well ventilated. Only suitable for zone 3 or above

## **Safety Precautions**

- Do NOT dry clothes or leave towels in the sauna.
- Do NOT touch the heater tube with your finger or metal tools.
- Do NOT touch the light when it is on.
- Do NOT use the sauna if you have or suffer from any of the following conditions:
  - Open wounds, eye diseases or serious burns.
  - Heat sensitivity, obesity, heart disease, blood pressure, circulatory system problems or diabetes.
  - Pregnancy
- Do not place pets into the sauna.
- Do not use the sauna after drinking excessive alcohol.
- This appliance is not intended for use by persons (including children) with reduced physical, sensory or mental capabilities, or lack of experience and knowledge, unless they have been given supervision or instruction concerning use of the appliance by a person responsible for their safety.
- Children should be supervised to ensure that they do not play with the appliance.
- Be careful when using the appliance in places where there are combustible materials.
- Do not use in an explosive atmosphere.
- Be aware that heat may be conducted to combustible materials that are out of sight.
- Do not leave the appliance unattended when it is switched on.
- Children under 16 years of age should not be allowed to use the sauna due to them being unable to regulate their temperature as effectively as adults. Any children under 16 years of age entering the sauna do so at their own risk.

**IF THE POWER SUPPLY CABLE IS DAMAGED IT MUST BE REPLACED BY A QUALIFIED ELECTRICIAN OR AS A COMPLETE ASSEMBLY AVAILABLE FROM THE MANUFACTURER OR ITS SERVICE AGENT.**

## Assembly and Installation

Tools Required for Installation: Screwdriver (included). 2 Persons recommended for safe assembly.

Please pay attention to the following before installation!

- Do not share the same plug with other appliances.
- Position the sauna on a flat and level surface.
- Do not splash the exterior with water. If the floor is damp, install a floor separator to keep the sauna dry.
- Do not store the flammable objects or chemical substances near the sauna.

*\*The example shown in these instructions is the model FIR-001. Other models vary in design but the procedure remains the same. For diagrams of the 4 and 4-6 person models please see the following 2 pages*

You may view videos of the assembly process at the following locations:

1 to 4 Person Sauna: <http://youtu.be/I9zaoLHowKU>

4 to 6 Person Corner Sauna: <http://youtu.be/KvyZNMCA6H8>



### Assembly Sequence for 4 Person Infrared Saunas

There are 2 benches for the 4 person models. Horizontal bench guides are located on the front and back panel. Slide the bench all the way in until it touches the side panel and is securely in place. It is advisable to install the front panel prior to installing the bench heaters on this model.



### Assembly Sequence for 4-6 Person Corner Infrared Saunas



Please install the benches before installing the front section when assembling this sauna.

### Assembly Process

Step 1)

Position the base section in the location where sauna is to be installed. (Please obey safety distances.) Ensure the 'Front arrow' sticker is facing up and is to the front.



## Assembly Process

Step 2)

Position the rear panel with pre-installed back rest at the back of the base section.



### Assembly Process

Step 3)  
Install left side panel. Ensure that hidden internal connectors are aligned. The panel then drops down to lock in place.



### Assembly Process

Step 4)  
Install right hand side panel.



## Assembly Process

Step 5)

Install front sauna panel with pre hung door making sure that all panels are sat flush with the sauna base.



### Assembly Process

Step 6)  
Install the door handle and using the 2 screws and screw driver provided.





### Assembly Process

Step 7)

Install the under bench heater and bench panel as shown in the images below. Please make sure that the heater connections are secure.



## Assembly Process

Step 8)

2 Persons may be needed for this step. Attach the roof panel to the sauna taking care to ensure that all the cables have been fed through the pre drilled holes.



### Assembly Process

Step 9)

Complete all the necessary connections on the roof of the sauna making sure that the cables are firmly connected. Please make sure that when connecting the ribbon cables you push the connectors together until you hear a 'click'.

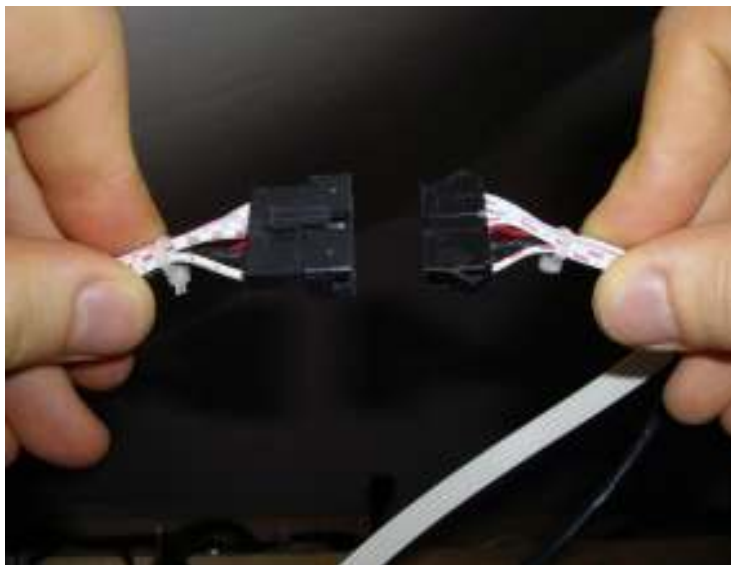

### Assembly Process

Step 9)

Complete all the necessary connections on the roof of the sauna making sure that the cables are firmly connected. Please make sure that when connecting the ribbon cables you push the connectors together until you hear a 'click'.



### Assembly Process

Step 10)

Install the Oxygen Ioniser using the two screws provided.

Connect the ioniser to the power source provided (the small black wire that is labelled 'Oxygen Ioniser').



### Assembly Process

Step 10a (Luxury Model)

Install the Oxygen Ioniser using the screw provided. The ioniser 'hangs' on the screw therefore you must ensure that enough of the screw is left protruding. Connect the ioniser to the power source provided (the small black wire that is labelled 'Oxygen Ioniser').



### Assembly Process

Step 11)

Once you have verified that the sauna is working correctly please install the 3 cover panels on the sauna roof panel. The middle panel must have the holes to the rear of the sauna over the internal vent. These can be secured with the screws provided. Please take care not to over tighten the screws.

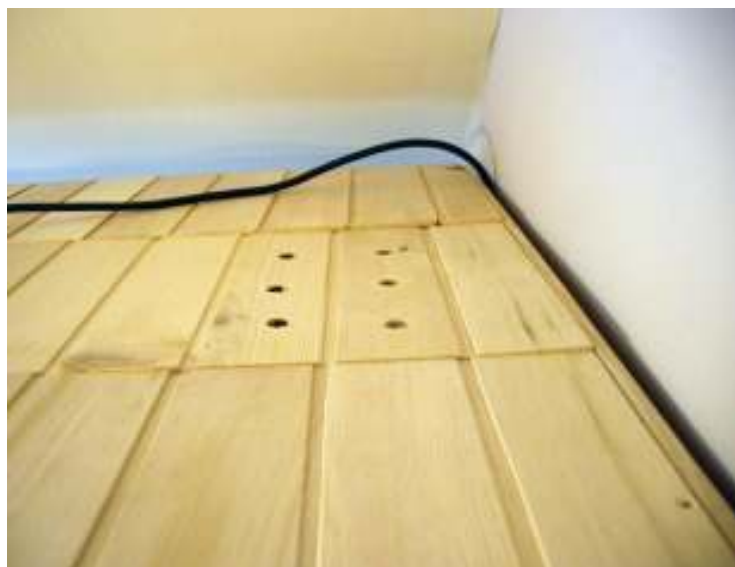

## Temperature Sensor

When sauna is in use, please point the temperature sensor vertical downward, as shown in the figure below to ensure the accuracy of the temperature display on the control panel.

### 1. Original Position



### 2. Vertical downward position





### Control Panel

- Connect the sauna to mains power supply.
- Press the On/Off key. The power LED illuminates.
- The temperature displays indicates the current temperature inside the sauna.

#### Adjust the temperature.

Press the key ▲ or ▼ under the temperature display to adjust the temperature. It changes in 10°F or 5°C increments for each press. The set temperature will blink for 15 seconds before returning to the actual temperature. Press the keys ▲ and ▼ together to select either Fahrenheit or Celsius. The highest temperature that can be set is 140°F or 60°C.

#### Adjust the time.

Press the key ▲ or ▼ under the Time & EQ Display to adjust the time. It changes in 5 minute increments for each press. The time scope is 5 to 60 minutes. The heaters will automatically switch off after the set time has elapsed.

#### Turn the light on/off.

Press the left key ☒ to turn the internal cabin light on or off.

Pressing the right key ☒ will turn on the external light on the model FIR-006 only. This feature is not available on other 'Classic' saunas.



## Operation of Ioniser

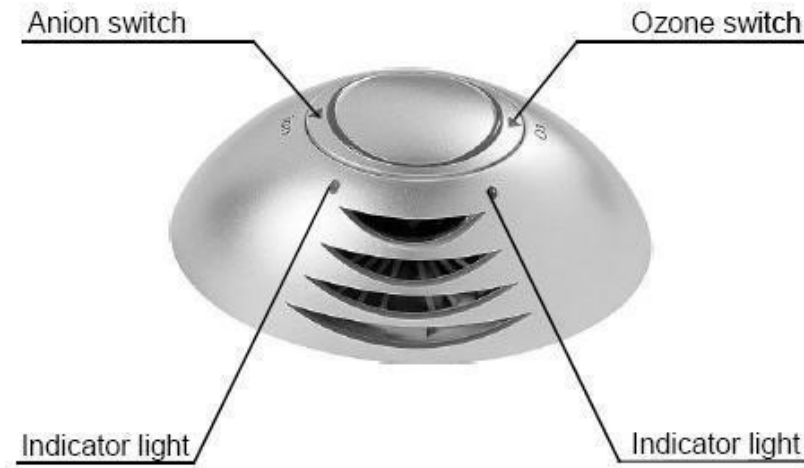

### SPECIFICATION

MODE	201B
OZONE OUTPUT	0.8mg/h
RATED VOLTAGE	DC-12V
POWER CONSUMPTION	5 watt
DIMENSION	12 × 9 × 17.5
N-ION DENSITY	>100 × 10 <sup>4</sup> 个 /cm <sup>3</sup>

Press the ion button (green light): it purifies the air and removes toxic substances including dust and odours.

Press the ozone button (red light): this has a sterilizing effect, do not use when the sauna is occupied.

#### **Produce Active Oxygen.**

The negative ion generated by ionization of high voltage in the air is also called Active Oxygen.

#### **Clear Air.**

Anions of negative charge can neutralize airborne dust with a positive charge, resulting in a natural reduction.

#### **Eliminate Peculiar Smells.**

The anion can be absorbed easily by various organisms which will charge their structures or transfer their energy so as to eliminate smells and germ s.

#### **Improve Pulmonary Function.**

With the anions being absorbed, the lungs absorption of oxygen will increase by 20% and the exhaustion of carbon dioxide by 15% so to improve the blood circulation and pulmonary function

**Prevent Air Conditioner Disease.**

Improve body reaction capacity and mobilize the reticular inner skin function as well as promote body immunity.

**Ozone Disinfection.**

We use the sterilization and disinfection of ozone without any second pollution or side effect as well as a timer functions.

**Fragrance Dispenser.**

A scented pad can be installed in the back of the module if fragrance is required. (See images below)



## Operation of Ioniser (Luxury Model)

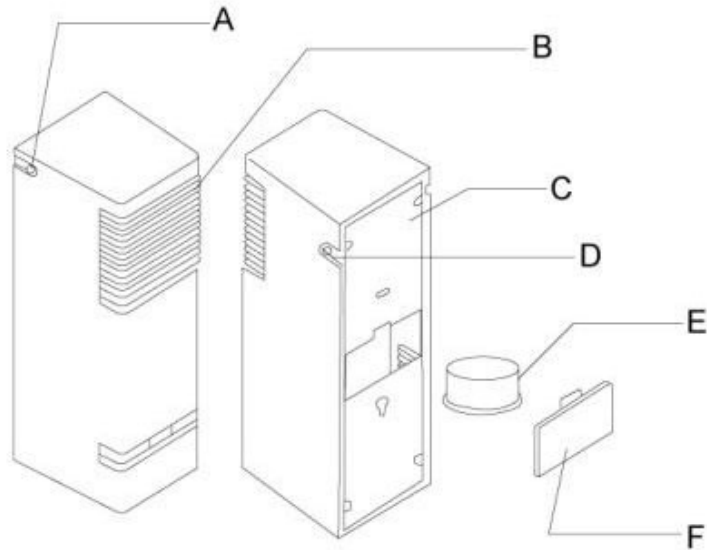

A. Power connection B. Function indicator lights C. Back cover  
D. Power/function switch E. Fragrance box F. Fragrance cover

- Open the fragrance cover(C), load the fragrance box and close the cover.
- Connect the unit to the power supply.
- Press the power switch (A) to start.
- Press the power/function change switch, when the green indicator light is on it is generating negative ions, when red light is lit; it is in the fragrance only mode.

## Fragrance Dispenser (Luxury Model)

The ioniser comes pre-loaded with a scent box. You can remove this and install your own should you wish to do so. Alternatively you can reuse the included scent box with your own oils.



**Operation of Ioniser**  
(Luxury Model)



**Adjust the FM radio station.**

Press the FM/MP3 button to select FM mode.  
 Press the Play/Pause (▶ ||) button to switch the FM Radio on.  
 Press and hold the backwards or forwards key (◀◀ or ▶▶) and the FM radio will automatically tune to the next station. Short press the ◀◀ or ▶▶ to fine tune the FM frequency.

**Adjust the volume.**

Press the Vol + and Vol – keys to increase or reduce the volume as required.

**Play music via USB.**

Ensure that all tracks on the USB memory stick are in the MP3 format.  
 Insert the USB memory stick into the USB port   
 Press the FM/MP3 button to select MP3 mode.  
 Tracks will begin playing automatically if the Play/Pause (▶ ||) button is already on play mode, otherwise press the Play/Pause (▶ ||) button to begin playback.  
 Use the backwards or forwards (◀◀ or ▶▶) button to skip selected tracks. A short press will cycle to the previous/next track. A long press will rewind/fast forward until the button is released.



**Play music via and MP3 player/iPod**

Select FM mode using the FM/MP3 button.  
 Insert one end of the provided cable into the "aux audio" port on the media panel and the other to the headphone output on the MP3 player/ iPod.  
 Press the Play/Pause (▶ ||) button to select playback.  
 Use the playback and volume controls on the MP3 player/iPod as normal.

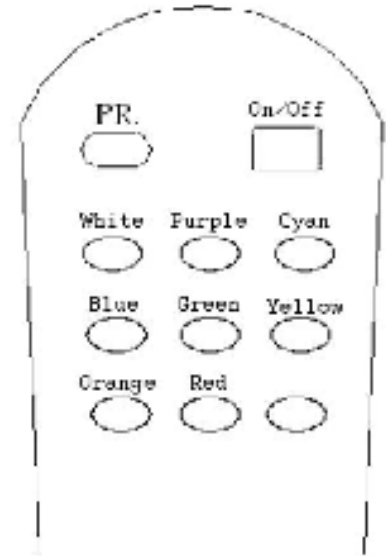
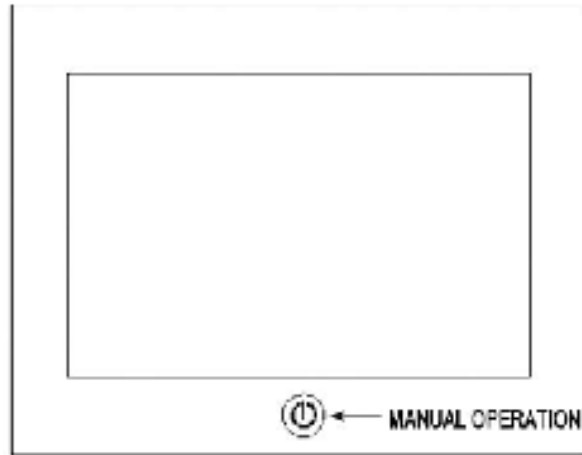
## Operation of Colour Light Therapy Unit (Luxury Model)



Key  
PR.: - Pause/Circulation

- When powered on the integrated light therapy unit will circulate from White, Red, Green, Blue, Yellow, Purple, Cyan and Orange.
- Press  and the light will stop on the next colour in the sequence. Press and hold  to turn the unit off.
- On the remote control press 'On/Off' to turn the unit on or off. Press 'PR' to pause the colour cycle or stay on a certain colour. You can also manually select the light colour by using the colour choice buttons.

## Tips for Use

- Set the temperature to a comfortable level, normally 40 to 50°C / 104 to 122°F.
- Allow approximately 8-15 minutes for the sauna to warm up.
- Perspiration will begin within 6 to 15 minutes after stepping into the unit. We recommend a sauna session does not exceed 30 minutes.
- When the temperature reaches the level set on the thermostat, the heaters will turn off and on periodically to maintain the desired temperature level inside the sauna.
- The front door/window/ceiling vent can be opened at any time to allow fresh air into the sauna.
- Drink plenty of water before, during and after a session to replenish lost fluids from the body.
- Taking a hot shower or bath before the sauna session will further accelerate perspiration.
- However, do dry off thoroughly before entering, for excessive water will stain or warp the wood. A shower after is refreshing.
- To absorb perspiration and keep the sauna tidy, place a towel on the bench and floor of the sauna. Keep one towel handy to wipe sweat from the body.
- Massage the affected areas to relieve sore and tense muscles.
- Shaving your face or legs with a razor while profusely sweating in a sauna yields an incredibly smooth skin without the use of gels or foams.
- Do NOT eat at least an hour before your sauna session. It is better to go in a sauna with an empty stomach.
- Do NOT use the sauna immediately after strenuous exercise.
- At the first sign of cold or flu, increasing your sauna sessions may be beneficial in boosting your immune system and decreasing the reproductive rate of viruses.
- Any area you want to achieve a deep heating should be moved close to the heaters.
- After the session is over, do not immediately get out. Let the body sweat a little more. Then, take a warm shower and finish it off with a cold shower to cool off completely.
- Consult your physician for the proper treatment or any other conditions.
- Open the ceiling vent to allow a flow of fresh air if required.



## Electrical Configurations

Model No.	Problem	Explanation	Solution
1	The power indicator does not light up	Bad connection to panel	Check ribbon cable/ connectors.
		The fuse is blown or the sauna is not plugged in.	Change the fuse or check the plug.
		PSU is faulty.	Replace the PSU.
2	The soft keys do not work.	Bad connection to panel	Check ribbon cable/ connectors.  Unplug sauna. Wait 1 minute and connect sauna back into power source.

## The heater Does Not Come On

Model No.	Problem	Explanation	Solution
1	One of the heaters does not heat up.T	Wiring to the heater is faulty.	Check all connections/wiring.
		The heater is defective.	Replace the heater.
2	None of the heaters function.	Sauna is not connected to a power source.	Connect sauna to a power source.
		The control panel is faulty.	Replace the control panel.
		The relay is faulty.	Replace the relay.
3	Bench heater does not function.T	It is not connected tightly into the outlet on the back panel.	Check the connection.
		The heater is faulty.	Replace the heater.

## Circuit Diagram

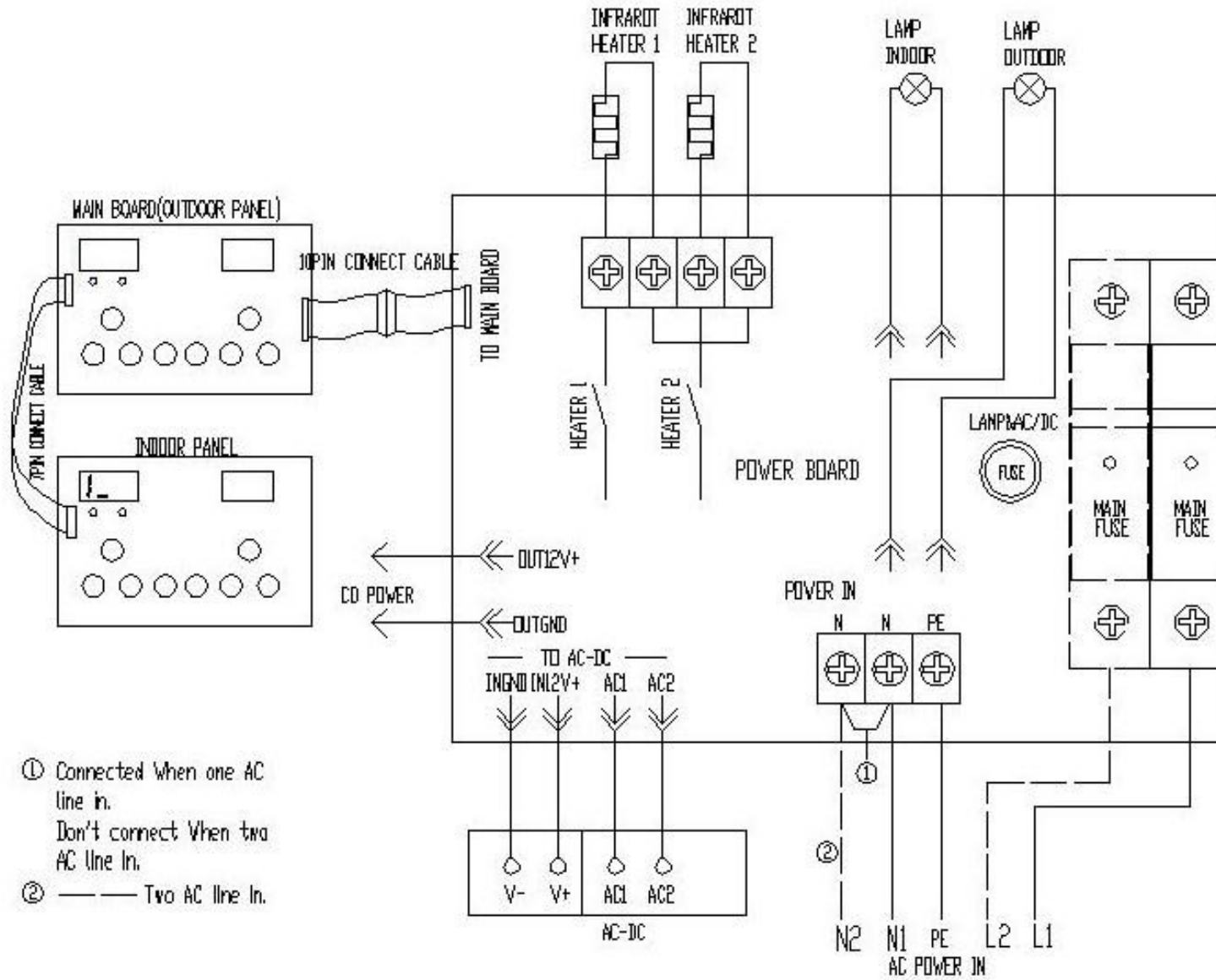

SaunaMed warrants that the sauna will be free from defects in materials and workmanship for a period of two (2) years for the electronic components and five (5) years for the cabin from the date of purchase. If the product proves defective during the warranty period, SaunaMed, at its option, will: (1) repair the product by means of telephone or email support or depot service at no charge for parts, (2) replace the product with a comparable product which may be new or refurbished or, (3) refund the amount paid for the product, less a reasonable allowance for usage, upon its return.

SaunaMed recommends the Customer first utilise support materials shipped with the product, product diagnostics, information contained on the Web, and email support. If unsuccessful, to obtain service under this warranty the Customer must notify SaunaMed Telephone Support or its authorised service representative of the defect before the expiration of the warranty period. Customers will provide appropriate assistance to Telephone Support personnel to resolve issues.

If telephone support is unsuccessful, SaunaMed or its authorised service representative will instruct the customer on how to receive warranty repair.

A description of the process may be obtained from the local SaunaMed Customer Support Centre or authorised SaunaMed reseller/distributor. Service is at SaunaMed or its authorised service representative's sole discretion and is considered an option of last resort.

In the maintenance of the product, SaunaMed may use new or equivalent to new parts, assemblies or products for equal or improved quality. All defective parts, assemblies, and products become the property of SaunaMed. SaunaMed may require the return of parts, assemblies and products to a designated SaunaMed representative from which the part, assembly, or product was originally purchased. Return and claims will be handled according to the current SaunaMed procedure.

These warranties shall not apply to any defect, failure or damage caused by improper use or improper or inadequate maintenance and care. SaunaMed shall not be obligated under these warranties:

- a) to repair damage resulting from attempts by personnel other than SaunaMed representatives to install, repair or service the product unless directed by a SaunaMed representative,
- b) to repair damage, malfunction, or degradation of performance resulting from improper use or connection to incompatible equipment,
- c) to repair damage, malfunction, or degradation of performance caused by the use of non SaunaMed supplies or consumables or the use of SaunaMed supplies not specified for use with this product,
- d) to repair an item that has been modified or integrated with other products when the effect of such modification or integration increases the time or difficulty of servicing the product or degrades performance or reliability,
- e) to perform user maintenance or cleaning or to repair damage, malfunction, or degradation of performance resulting from failure to perform user maintenance and cleaning as prescribed in published product materials,
- f) to repair damage, malfunction, or degradation of performance resulting from use of the product in an environment not meeting the operating specifications set forth in the user manual.
- g) to repair damage, malfunction, or degradation of performance resulting from failure to properly prepare and transport the product as prescribed in published product materials
- h) to replace items that have been abused, misused, or tampered with in any way;
- i) to install replacement items that are considered customer replaceable;
- j) to provide control panel software or firmware updates or upgrades.

Any service identified in the above list and provided by SaunaMed at the Customer's request shall be invoiced to Customer at SaunaMed' then current rates for parts, labour and travel.

**THE ABOVE WARRANTIES ARE GIVEN BY SAUNAMED WITH RESPECT TO THIS PRODUCT AND ITS RELATED ITEMS IN LIEU OF ANY OTHER WARRANTIES, EXPRESS OR IMPLIED. SAUNAMED AND ITS VENDORS DISCLAIM ANY IMPLIED WARRANTIES OF MERCHANTABILITY OR FITNESS FOR A PARTICULAR PURPOSE OR ANY SIMILAR STANDARD IMPOSED BY APPLICABLE LEGISLATION. SAUNAMED' RESPONSIBILITY TO REPAIR, REPLACE, OR OFFER A REFUND FOR DEFECTIVE PRODUCTS AND RELATED ITEMS IS THE SOLE AND EXCLUSIVE REMEDY PROVIDED TO THE CUSTOMER FOR BREACH OF THESE WARRANTIES.**

Some states, provinces, and countries do not allow the exclusion or limitation of incidental or consequential damages or exclusions or limitations on the duration of implied warranties or conditions, so the above limitations or exclusions may not apply to you. This warranty gives you specific legal rights, and you may also have other rights that vary by state, province, or country.

**TO THE EXTENT ALLOWED BY LOCAL LAW, EXCEPT FOR THE OBLIGATIONS SPECIFICALLY SET FORTH IN THIS WARRANTY STATEMENT, IN NO EVENT SHALL SAUNAMED AND ITS VENDORS BE LIABLE FOR ANY INDIRECT, SPECIAL, INCIDENTAL OR CONSEQUENTIAL DAMAGES (INCLUDING LOSS OF PROFITS) WHETHER BASED ON CONTRACT, TORT, OR ANY OTHER LEGAL THEORY AND IRRESPECTIVE OF WHETHER SAUNAMED OR THE VENDOR HAS ADVANCE NOTICE OF THE POSSIBILITY OF SUCH DAMAGES.**

For your record please complete the following information. You need to refer to this information when calling the manufacturer for customer service.

Date of Purchase	
Date of Delivery	
Model Number	
Serial Number (printed on the inside of the back panel)	
Dealer Information (Name & Contact Number)	